

适用专业	三年制高职软件技术专业	课程代码	0102073
开设时间	第 6 学期	学 分	6 学分

:

1.

Web

UI

Java

2.

HTML5 Java

Web

3.

1

15

1

1

2

2

1

2

50%

1

“

”

50%

2“

”

1

		%
		5
30		15
		10

20		5
		10
		5

表 9 比北沿江铁路环评标准

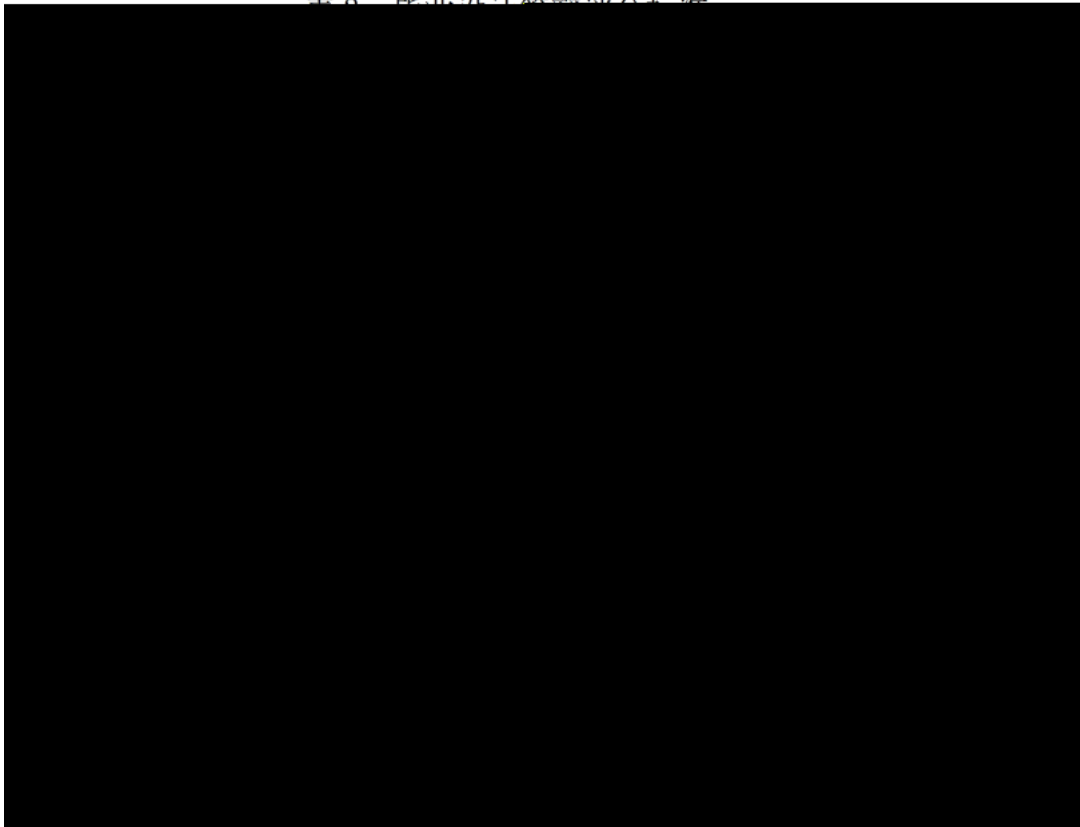

1	j avaweb
2	ssm
3	Javaweb
4	
5	j avaweb
6	
7	
8	
9	
10	j avaweb
11	j avaweb
12	coke
13	Javaweb
14	ssm
15	j avaweb
16	
17	
18	
19	

20	
21	
22	
23	
24	
25	
26	
27	
28	
29	
30	
31	vue
32	Spring boot
33	Android
34	JSP
35	html 5
36	JAVA
37	html 5
38	SSM
39	SSM
40	Java
41	jquery

42	SSM ZZ
43	Androi d
44	JS
45	JS
46	SSM
47	
48	
49	
50	
51	
52	
53	
54	
55	SSM
56	
57	Spri ng Boot
58	
59	
60	
61	html 5
62	Java
63	

64	
65	Java
66	JSP
67	PHP
68	j ava
69	JavaWeb
70	html 5
71	
72	Java
73	web
74	
75	JavaWeb
76	JavaWeb
77	JavaWeb
78	JavaWeb
79	Java
80	Java
81	
82	
83	Java
84	j ava
85	Java

86	Java
87	SSM
88	ssm
89	Java
90	Java
91	Java web
92	PHP
93	SSM
94	j ava web
95	Java
96	ssm
97	Java web
98	Java Web SSM
99	
100	Java Web
101	ssm
102	SSM
103	web
104	j sp
105	spring boot
106	
107	j sp

108	
109	
110	
111	
112	j sp
113	SSM
114	j ava web
115	
116	
117	
118	
119	R
120	
121	
122	
123	
124	ABC
125	
126	
127	
128	
129	

130	
131	
132	
133	
134	
135	
136	
137	
138	
139	
140	
141	
142	
143	
144	
145	
146	
147	Web
148	JavaWeb
149	Web
150	
151	

× × ×

2017

1

1		3
1.1		3
1.1.1		3
1.1.2		4
1.2		4
1.2.1	XXXXXX		4
1.2.2	XXXXXX		4
1.1.3	XXXXXX		4
1.3		5
1.4		5
2		6
2.1		6
2.2		6
2.3		7
2.3.1	1		7
2.3.2	2		9
2.3.3	3		9
3		10
3.1		10
3.2		10
3.3		10
3.3.1	1		11
3.3.2	2		13
3.3.3	3		13

3.4	13
3.4.1	13
3.4.2	14
3.4.3	14
3.4.4	14
4	15
4.1	XXXX 1	15
4.1.1	XXXX 1	15
4.1.2	XXXX 1	15
4.2	XXXX 2	17
4.2.1	XXXX 2	17
4.2.2	XXXX 2	17
4.3	4.3 XXXX 3	18
4.3.1	XXXX 3	18
4.3.2	XXXX 3	18
5	18
5.1	XXX	18
5.2	XXX 2	20
5.3	XXX 3	21
6	21
6.1	XXXXXXXX	21
6.2	YYYYYYYY	22
6.3	<i>ZZZZZZZZ</i>	22
7	22



2 0 20

X XXXXX XXXXXXX
XXXXX
XXXX XXXXX
XXXX

XXXXXX/Intranet

IT XXXXXX ,

--- ,
XXXXXXXXXX

XX

XX
XX 0
20 2

XX
XX
XX 0
20 2

XX
XX
XX

XXXXXX XXXXXX Server Pages Sun Microsystems



XXXXXXXXX+tomcat+mysql
XXXXXXXXX , XXXXXX
tomcat ,
TOMCAT
mysql
XXXXXX+XXXXXX+XXXXXXBean MVC ,

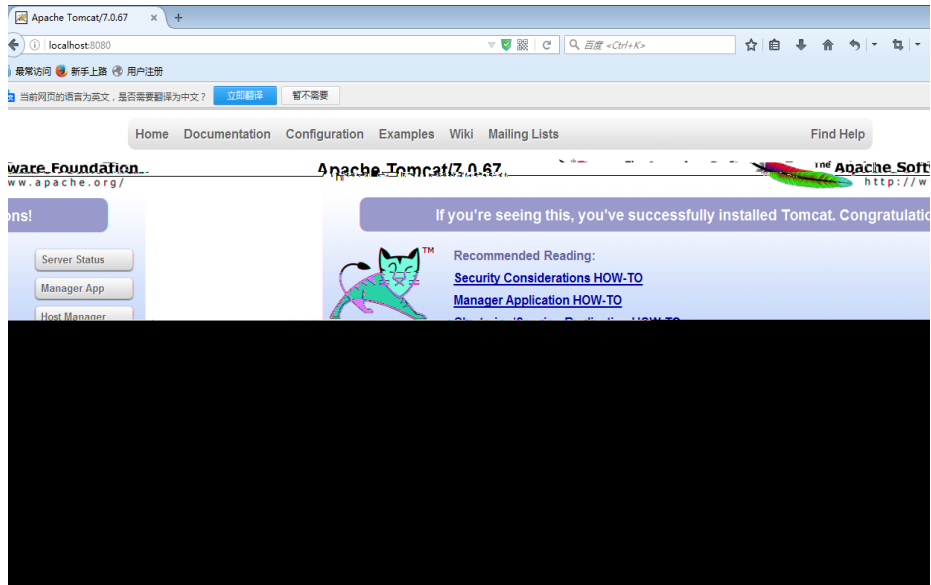

1-1 tomcat

http://localhost:8080

http://localhost:8080/WebShop

/admin/123456

```

XXXXXXXXX                XXXXX

1      1      XXXXXX                XXXXX
          XXXXXX                XXXXX
          XXXXXX                XXXXX
          XXXXXX                XXXXX

2      2      XXXXXX                XXXXX
          XXXXXX                XXXXX
          XXXXXX                XXXXX
          XXXXXX                XXXXX

3      3

XXXXXXXXX                XXXXX

```

XXXXXX

XXXXXX

XXXXXXXXXXXXXXXXXXXX

1

2

3

4 XXXXXXXXXXXXXXXX.....

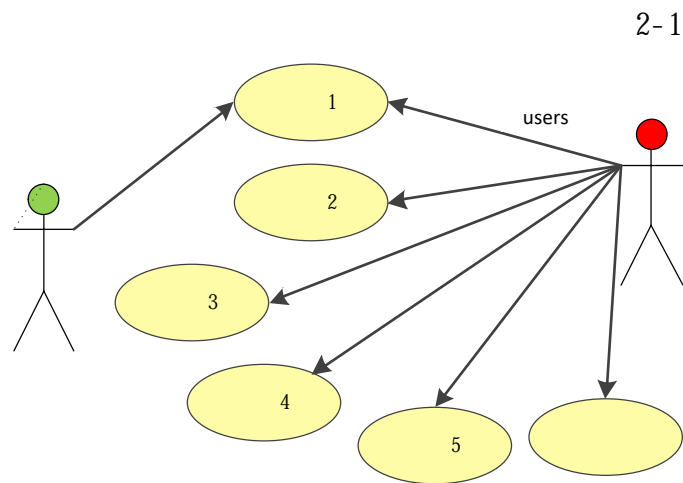

2-1

2-1 XXXX

XXXXXX

XXXXXX

XXXXXX

XXXXXX

XXXXXX

XXXXXX

XXXXXX

XXXXXX

1

2-2

AAAA BBBB CCCC DDDD EXX

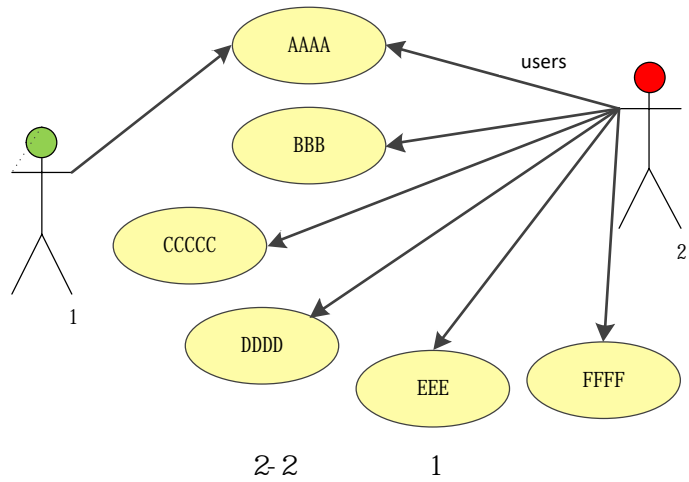

2-2

1

1

2-3

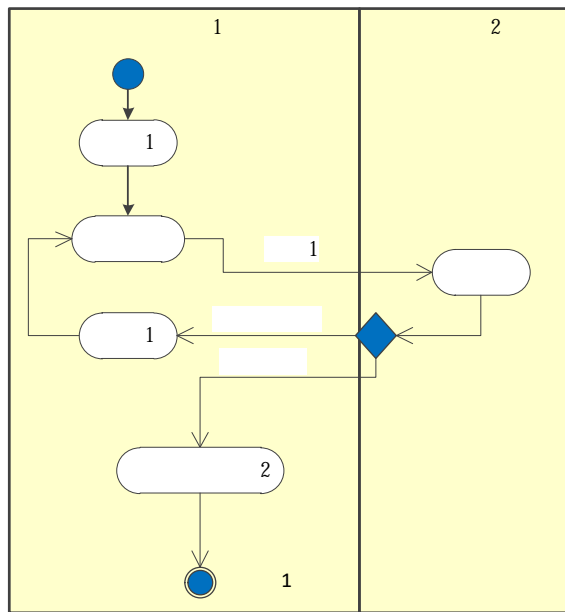

2-3

1

login.jsp

1.

2.

3.

4

4.

5.

6.

“ ” “ ” “ ”

main.jsp

BBBB

2-2

XXXXXX

2-2 BBBB

.....

XXXXXXX
XXXXXXX

XXXXX
XXXXX

XXXXXXX

3-1

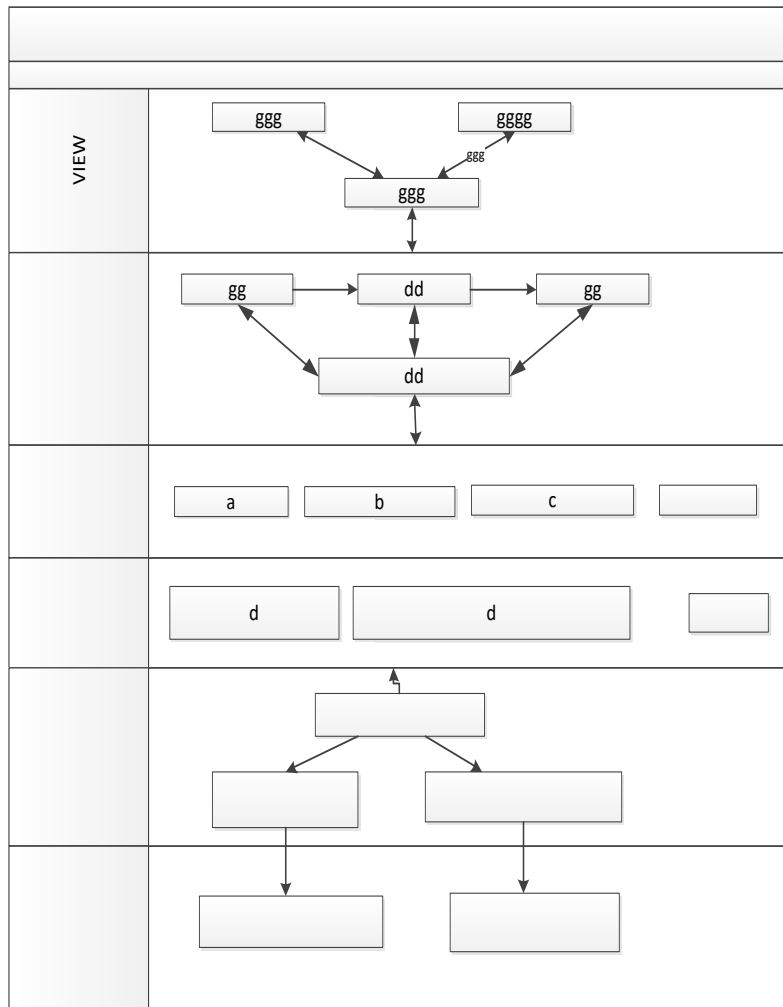

3-1 XXXX

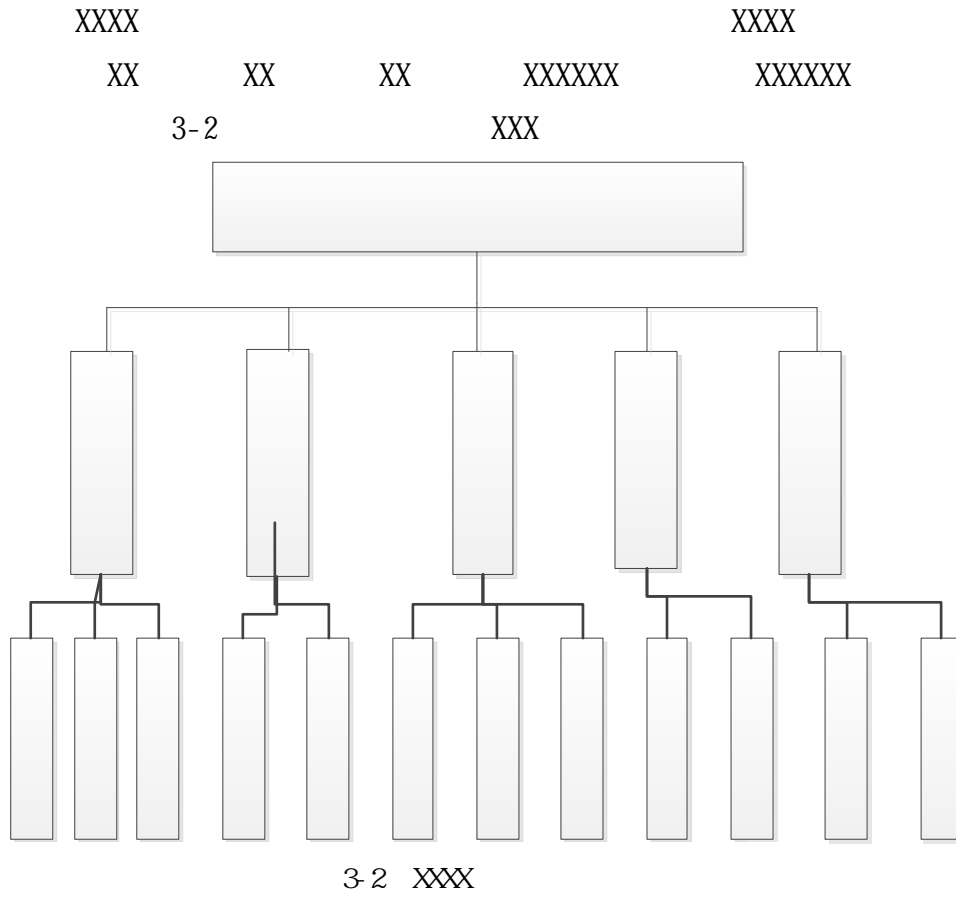

3-3

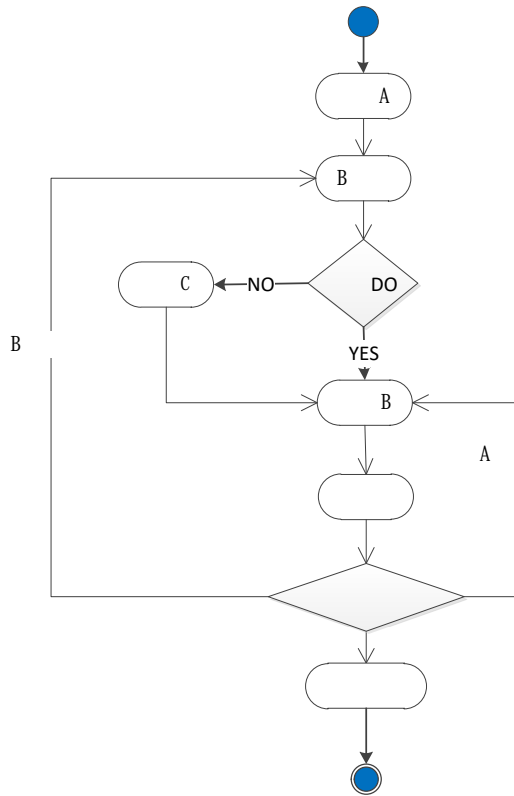

3-3 XXXX

1

3-1 XXXX

1

	XXX

XXXX

1

XXXX

XXXX

XX XX XX XXX

3-4 YYYY 2

3-2 YYYY 2

YYYYY 2

1

,

2

3NF

3NF

3-4

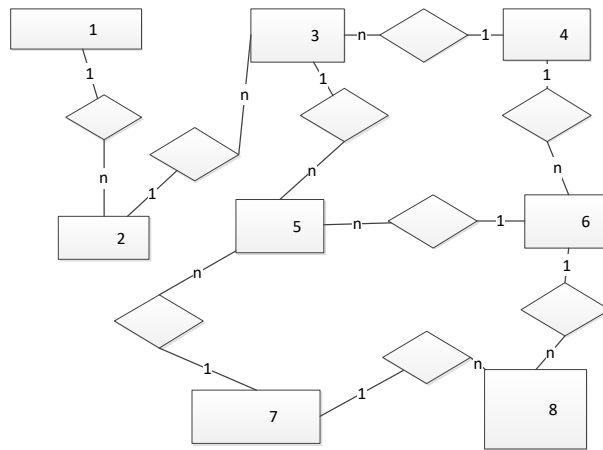

3-5 XXXX E-R

ER

XXXX

E-R

1 2 3

3-3

XXX

XXX, XXX, XX, XXX

3-3 OOOO

1 XXXX

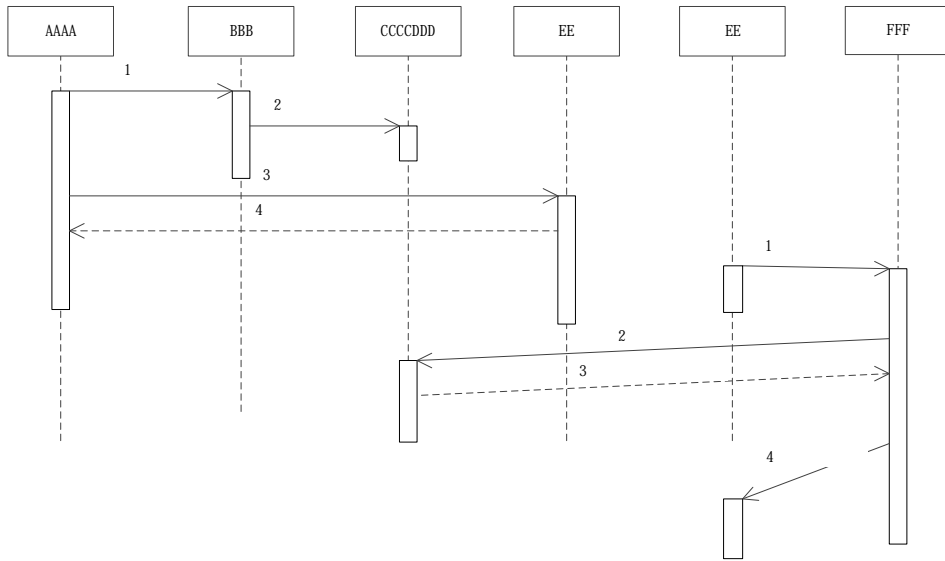

4-1 XXXX

XXXXXX

4-2

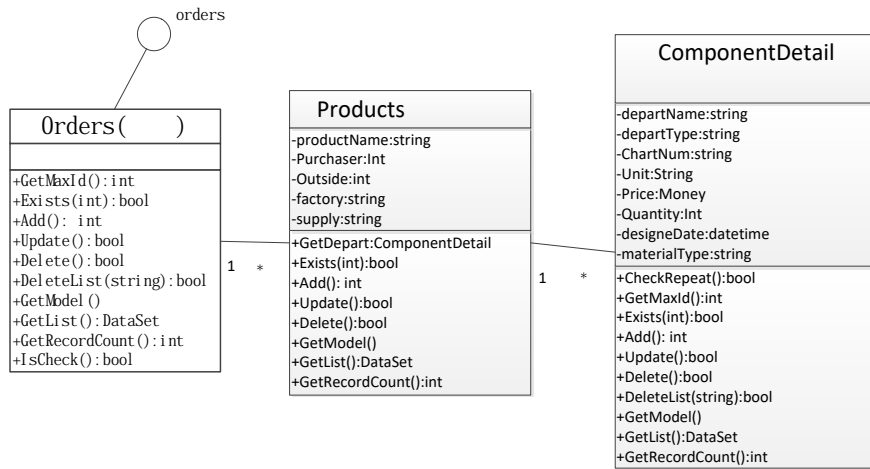

4 2 XXX

4-1

4 1 XXXX

People

XX
XXXXXX

XXXXX

3 UML
XXXX

4-

XXXXX

4-4

4-2



XX
XXXXXX

XXXXX

5 UML
XXXX

4-

XXXXXX

4-6

4-3

5-1

MAIL ,

E-



5-1

1

```

UserInfoAdo uia=UserInfoAdo.initializeUIA();
PrintWriter out = response.getWriter();
String strName = CommonUtil.NullToString(request
        .getParameter("userName")).trim();
String strPwd = CommonUtil
        .NullToString(request.getParameter("userPwd")).trim();
String strCode = CommonUtil.NullToString(request.getParameter("code")).trim();

HttpSession session = request.getSession();
String rand = (String) session.getAttribute("rand");

```

2

```

//
    if (!strCode.equalsIgnoreCase(rand)) {
//
if (false) {
    errorMessage(out, "                ");
    return;
}
UserInfoBean userBean = uia.getUserBean(strName);

//

```

```

if (userBean == null) {
    errorMessage(out, "                ");
    return;
}

```

3

```

//                3
int count = 0;
if (!userBean.getPassword().equals(strPwd)) {

    if (session.getAttribute("count") == null) {
        session.setAttribute("count", new Integer(count));
    }
    count = Integer.parseInt(session.getAttribute("count").toString());
    count = count + 1;
    session.setAttribute("count", new Integer(count));
}

```

4

```

//
if (getUserIsOnLine(strName)) {
    errorMessage(out, "                ");
    return;
}
//
if(request.getParameter("flag").equals("0")){ //
    if(userBean.getUserFlag()==1){ //
        out.println("<script>alert('
');window.history.back();</script>");
        return;
    }
    if(userBean.getLocked()==1){
        out.println("<script>alert('
',
');window.history.back();</script>");
        return;
    }
}
}

```

XXXXXXXX

6-1 6-2

6-1 XXXXXXXX

	JIECHU_01
	1 2005014562
	2
	3

6-2 XXXXXXXX



. [J] “ J ” .
A B

[1] . [J]. 2018 21 3 281 288

. [M] “ [M] ” .

[2] . [M]. 2 . 2016

